



HYDROSENSE 3420 On-line Oil in Water Monitor

User Manual

Arjay Engineering Ltd.
Oakville (Toronto), Canada, L6H 6C9

Tel . ++1 (905) 829-2418
Fax. ++1 (905) 829-4701
North America 1-800-387-9487



www.arjayeng.com
arjay@arjayeng.com

TABLE OF CONTENTS

SPECIFICATIONS	4
1.0 INSTRUMENT OVERVIEW	5
1.1 Description	5
1.2 Unpacking and Inspection.....	5
1.3 The Display	5
1.4 The Touch Pad.....	6
1.5 Vapor Purge	6
2.0 SAFETY	7
3.0 INSTALLATION AND COMMISSIONING	8
3.1 Mounting & Site Selection	8
3.2 Plumbing	9
3.2.1 Drain Vent:.....	9
3.2.2 Wetted Materials:.....	10
3.3 Electrical Connections.....	10
3.3.1 Power:	11
3.3.2 RS-485:	11
3.3.3 Relays:.....	11
3.3.4 4-20 mA:	11
4.0 OPERATION	12
4.1 Routine Measurement.....	12
4.2 Security Access Feature	12
5.0 INSTRUMENT CONFIGURATION	13
5.1 Selecting the Output (O/P)	13
5.2 Setting the 4-20 mA	13
5.3 Configuring the RS-485 Port	14
5.4 Configuring the Alarms	14
5.4.1 Alarm 1	15
5.4.2 Alarm 2	16
5.5 Offset Setting	16
5.6 Setting the CAL1 and CAL2.....	16
5.7 Enabling the Security Access Code.....	16
5.8 Extended Settings	16
5.9 Speed of Response.....	17
5.10 Displayed Resolution	17
5.11 LCD Backlight Brightness	17
5.12 Setting the Units.....	18
5.13 Ultrasonic Cleaning.....	18
5.14 RS-485 Parameters	18
5.15 Desiccant Alarm	18
5.16 Saving Configuration Settings.....	18
5.17 Configuration Settings Sheet	19
6.0 INSTRUMENT CALIBRATION	20
6.1 Calibration Methods	20
6.2 Calibration Procedures	20
6.3 Calibration Error	21
7.0 ADDITIONAL FEATURES AND OPTIONS	22
7.1 Backlit LCD	22
7.2 Ultrasonic Cleaning.....	22
7.3 RS-485 Outputs	22

- 8.0 TROUBLESHOOTING MAINTENANCE.....23
 - 8.1 HS3420 Fault Detection.....23
 - 8.2 System FAIL Message.....23
 - 8.3 Diagnostic Chart.....24
 - 8.4 Technical and Customer Assistance.....24
- 9.0 ROUTINE MAINTENANCE.....25
 - 9.1 Cleaning the Flow Through Cuvette25
 - 9.2 Replacing or Installing the Desiccant Pouch25
 - 9.3 Replacing the Source Lamp.....25

SPECIFICATIONS

Measurement Range	0-100 PPM
Accuracy	±5% of span
Resolution	0.1ppm
Response Time	Adjustable
Display	Multi-Line Liquid Crystal Backlit Display
Alarms	Two Programmable, 120-240VAC 2A Form C Relay
Analog Output	Powered 4-20mA, 600 Ω drive
Communications Port	Bi-directional RS-485, Modbus Optional
Maximum Water Pressure	Integral pressure regulator rated 1380kPa (200 PSI.) Also refer to Flow Rate
Flow Rate	100 ml/min. – 1 liter/min. (.026-.26 Gal/min)
Operating Temperature	1°C – 50°C (34°F – 122°F)
Wetted Materials	Nylon, Borosilicate Glass, Silicon, Polypropylene, Stainless Steel
Sample Temperature Range	1°C – 50°C (34°F – 122°F)
Power Supply	100 – 240 VAC, 47 – 63 Hz, 80VA
Insulation Rating	Double Insulated, Pollution Degree 2, Overvoltage Category II
Environmental Conditions	Not recommended for outdoor use. Altitude up to 2000 meters Up to 95 % RH (non-condensing)
Enclosure Rating	IP 66 /NEMA 4X
Certifications	CE Approved, ETL listed to UL 3111-1 & ETL Certified to CSA 22.2 No. 1010-1-92
Shipping Weight	2.5 kg (5.5 lbs.)
Warranty	1 Year from date of shipment

1.0 INSTRUMENT OVERVIEW

1.1 Description

The HS3420 oil in Water monitor from Arjay Engineering Ltd. has been designed for municipal and industrial applications to measure PPM levels of hydrocarbons in aqueous solutions. Typical applications include PPM trace amounts of oil in effluent water from storm water runoff, oil in cooling water, produced water, and oil/water separators. Other measurements and mediums can be monitored on request (i.e. colorants in fluids, etc.).

A continuous sample is directed into the cuvette using a pumped or process pressure source. A minimal flow rate is required. The sample is released from the cuvette by a gravity flow to a drain or sump.

1.2 Unpacking and Inspection

The table below indicates the items in the shipment.

Item	Quantity
HS3420 c/w Field Terminal Box & Flow Through Assembly	1
User Manual	1
Desiccant Pack	1
Cuvette (Single Pack)	1
Tubing Kit: 1 - shutoff clamp 1 - backpressure valve 2 - connecting tubing with fittings for flow through assembly	1

Remove the instrument from the packing carton. Carefully inspect all items to ensure that no visible damage has occurred during shipment. If the items received do not match the order, please immediately contact the local distributor or the Arjay Engineering Ltd. Customer Service department.

Note: The cuvette must be installed prior to operating the instrument.

1.3 The Display

Figure 1 illustrates all the items that can appear on the display. The upper row of the display (1) is used for reporting the oil ppm levels and to provide user guidance in the customer setting routine. The lower row of the display (2) is used to communicate error messages and provide user guidance. The display has two icons (3) that are used to indicate the use of access code and offset mode. In addition, mode arrows (4) are used to indicate the current instrument operating mode; AUTO (normal operation), CAL (calibration) and CONFIG (configuration).

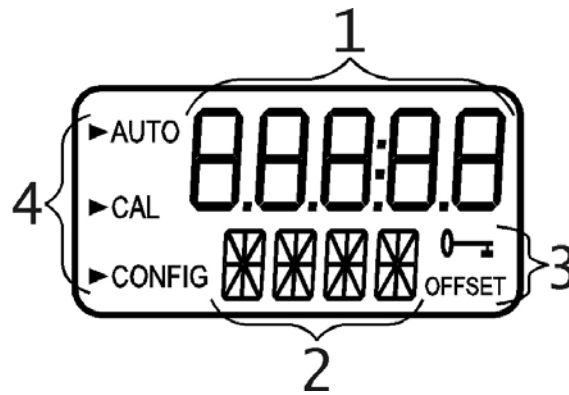

Figure 1 - Display used in the instrument

All items used on the display are shown in this figure

1.4 The Touch Pad

Figure 2 illustrates the touch pad. The touch pad has four buttons: **MODE/EXIT**, ↵, ▲, and ▼. The **MODE/EXIT** button is used to cycle between the three operational modes of the instrument: **CAL**, **CONFIG**, and **AUTO** (Measurement) mode. The ↵ button enters the option (or mode that is highlighted or chosen. The ▲ and ▼ buttons are used to change settings.

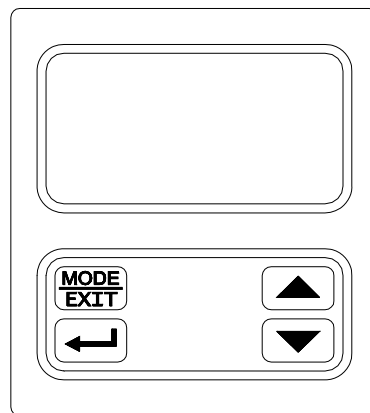

Figure 2: The HS3420 Touch Pad.

1.5 Vapor Purge

The HS3420 is equipped with a continuous vapor purge system. A replaceable desiccant pouch in the lower portion of the instrument dries the air. System heat is used to warm the air. A fan inside the instrument continuously circulates heated dry air around the optical well and the flow through cuvette. This feature eliminates the need for a dry purge line.

The HS3420 monitors the replaceable desiccant pouch condition continuously. The LCD display will show DESC on the lower line in the event that the desiccant pouch needs replacement. Replacement desiccant pouches are available from Arjay Engineering Ltd.. or the local representative . Refer to section 9.2 *Replacing or installing the Desiccant Pouch*.

The desiccant can activate an alarm to notify the operator of a saturated desiccant. See section 5.15 *Desiccant Alarm*.

2.0 SAFETY

This manual contains basic instructions that must be followed during the commissioning, operation, care and maintenance of the instrument. The safety protection provided by this equipment may be impaired if it is commissioned and/or used in a manner not described in this manual. Consequently, all responsible personnel must read this manual prior to working with this instrument.

In certain instances **Notes**, or helpful hints, have been highlighted to give further clarification to the instructions. Refer to the *Table of Contents* to easily find specific topics and to learn about unfamiliar terms.

3.0 INSTALLATION AND COMMISSIONING

Prior to use for the first time, the supplied desiccant pouch will need to be installed. Refer to section 9.2 *Replacing or Installing the Desiccant Pouch*.

3.1 Mounting & Site Selection

The instrument is designed for wall mounting. If wall mounting is not practical, the instrument can be mounted on any suitable level surface. For ease of service there should be about 20 cm (8") free area above the instrument; this will ensure enough room for calibration and cuvette maintenance. Choose a location that is easily accessible for operation and service and ensure that the front display rests at eye level. The overall mounting dimensions of the instrument are shown in Figure 3. The recommended mounting screws are M6 (1/4") for the instrument enclosure and M4 (3/16") for the field terminal box. The HS3420 is designed to have the field terminal box cradled under the sensor portion of the instrument. It is recommended that the field terminal box be mounted first, and then the rest of the instrument be mounted on top. The template on the last page of this manual may be used to establish mounting hole locations.

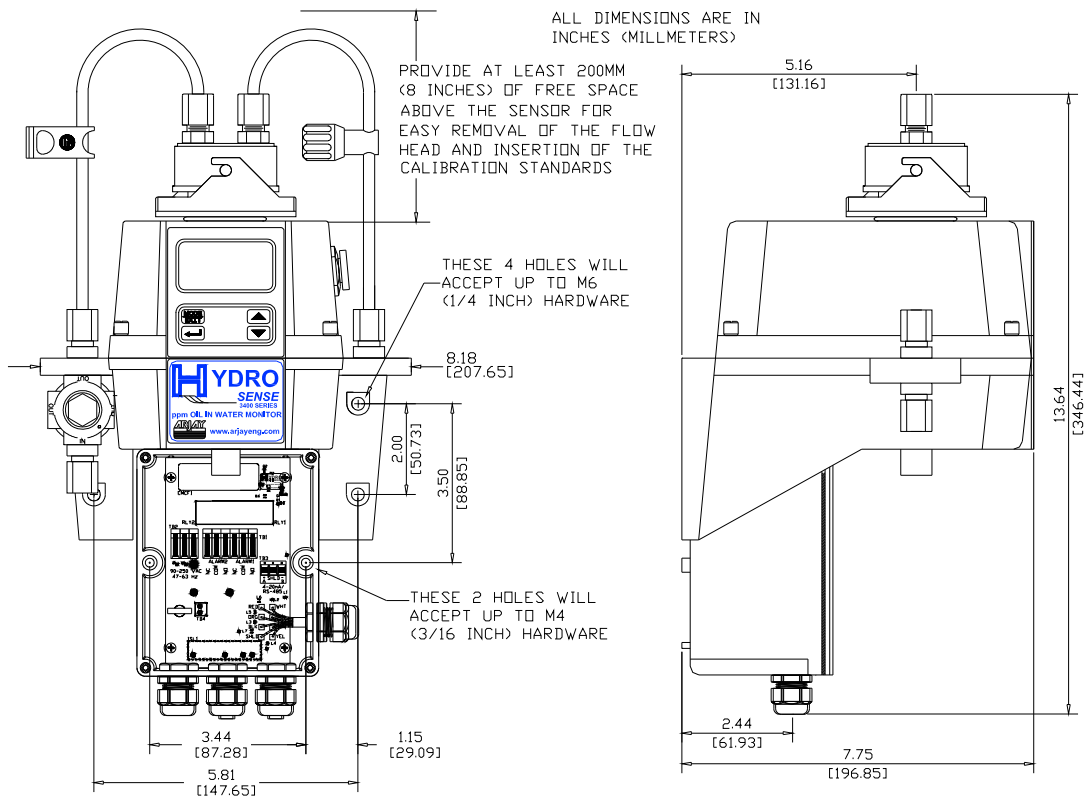

Figure 3: Overall Mounting Dimensions of the Instrument

It is critical that the instrument be mounted as close as possible to the sampling point to ensure a quick response time (within 2-3 meters (6-10 ft) of the sampling point).

3.2 Plumbing

The recommended plumbing for the instrument is shown in Figure 4. The instrument is designed to require very little head pressure to operate; around 6.9kPa (1 PSI). The flow through cuvette is rated for a flow of 100ml/min. – 1 liter/min. (0.026-0.26Gal/min). The integral pressure regulator is rated for a maximum pressure of 1380 kPa (200 PSI.). The maximum allowable fluid temperature is 50°C (122°F).

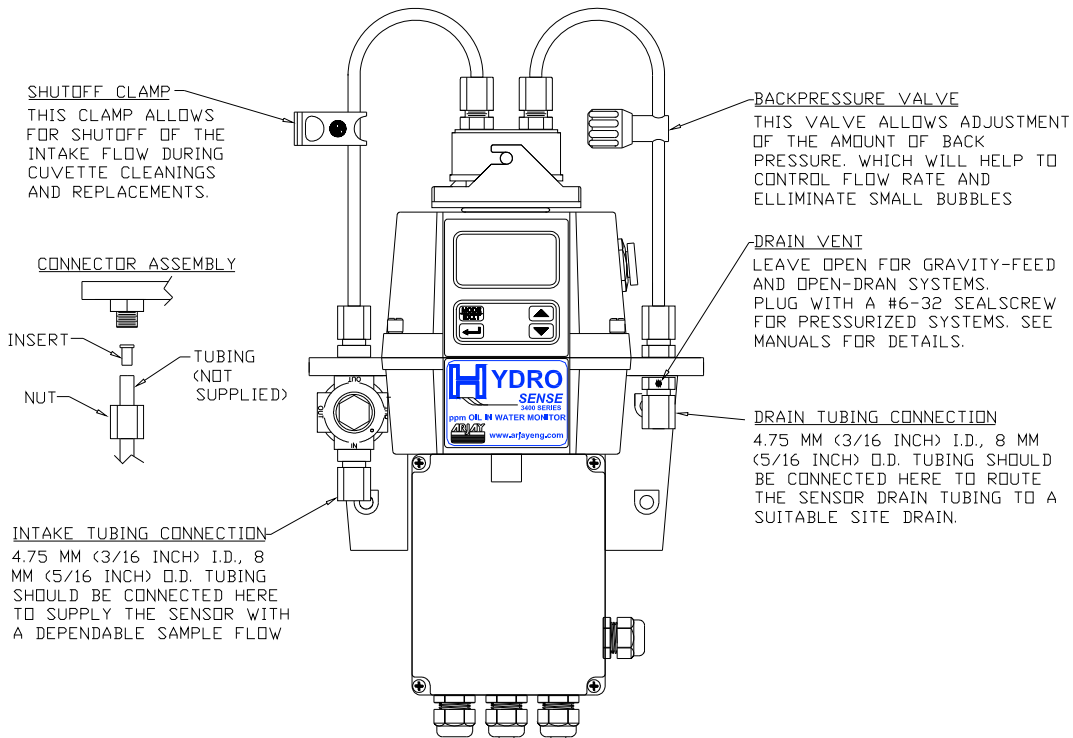

Figure 4: Recommended Plumbing for the Instrument

The instrument is equipped to be plumbed using 4.75 mm (3/16") ID, 8 mm (5/16") OD flexible tubing. Opaque tubing should be used if the tubing will be exposed to sunlight, to prevent algae growth.

In figure 4, there are two flow devices shown. The one on the input side is a shutoff clamp used during cuvette maintenance. The other device is a backpressure valve. Backpressure may be required to prevent air from coming out of solution, which may be observed as tiny air bubbles.

3.2.1 Drain Vent:

The HS3420 has been fitted with a drain vent in the "OUT" bulkhead fitting. This fitting allows for atmospheric equalization, thus helping to alleviate bubble formation in the cuvette. Refer to Figure 4.

Upon initial flow minor leakage may occur through the drain vent. This will subside once normal flow is established.

For some high pressure systems, where the vent hole continuously leaks, a 6:32 seal screw is provided which should be inserted into the vent hole and tightened.

3.2.2 Wetted Materials:

Arjay Engineering Ltd. Accepts no responsibility for damage caused by the introduction of vapors, fluids or other materials into the instrument process stream which is not compatible with the instrument's wetted materials. A list of the wetted materials can be found in the specifications on page 4 of this manual.

3.3 Electrical Connections

All of the electrical connections to the instrument are made through the field terminal box, which should be located directly under the sensor portion of the instrument. The connections are labeled within the terminal box and are self-descriptive (see Figure 5). Please follow all local and government recommendations and methods for installation of electrical connections to and between the instrument and other peripheral devices.

Plugs are inserted into the alarm and 4-20mA/RS-485 cable bulkheads when shipped, to ensure a watertight seal. These plugs should be removed and discarded when cabling to either of these connections.

The power cable bulkhead will accept cable diameters from 5.8mm (.230 in.) up to 10 mm (.395 in.). All terminals are designed to accept wires in the range of 14-28 AWG. All wires should be stripped to a length of 6 mm (1/4"). A strain relief strap is provided to reduce tension on the power terminals.

It is the user's responsibility to assure that the watertight seal is maintained after the terminal box has been wired for operation. If any of the bulkheads are not tightened properly around a cable or plug, the ratings of the instrument will be jeopardized and there is a possibility of creating a shock hazard.

Note: Only qualified electricians should be allowed to perform the installation of the instrument as it involves a line voltage that could endanger life.

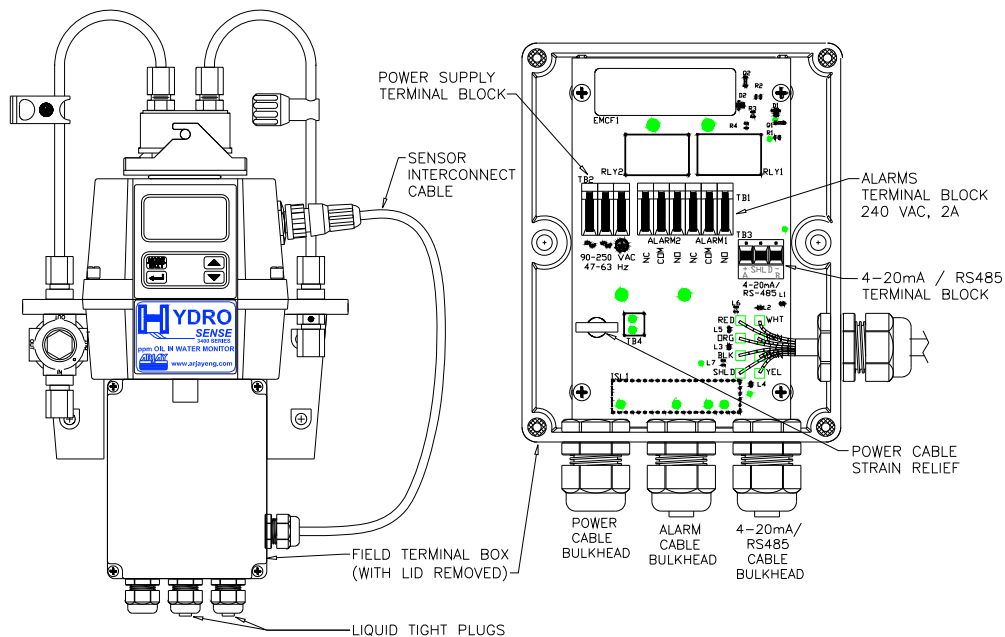

Figure 5: Electrical Connections for the Instrument

3.3.1 Power:

The instrument is equipped with a 100-240 VAC, 47-63 Hz switching power supply; please verify that the line voltage falls within these specifications. It is recommended that a circuit breaker be placed prior to the power connection to allow for service. While making connections, refer to Figure 5. **The HS3420 is not supplied with a power cord.**

3.3.2 RS-485:

The RS-485 half-duplex (2-wire) digital interface operates with differential levels that are not susceptible to electrical interferences. This is why cable lengths up to 3000 ft can be implemented. The last device on each bus may require terminating with a 120-ohm resistor to eliminate signal reflection on the line. Do not run RS-485 cables in the same conduit as power.

To prevent damage to the instrument, ensure that power is disconnected prior to making connections. For ease of connecting, remove the plug in terminal block. Connections are labeled beneath this termination.

3.3.3 Relays:

The Alarm 1 and Alarm 2 relays are mechanical relays rated at 240 VAC 2A. Please note that the relays are labeled NO (Normally Open), NC (Normally Closed) and C (Common). As these alarms are configured fail-safe, the normal condition is with power applied to the HS3420 and in a non-alarm condition. Operation of these alarms is covered in section 5.4 *Configuring the Alarms*.

3.3.4 4-20 mA:

The 4-20 mA output is driven by a 15 VDC power source and can drive recorder loads up to 600 ohms. This 4-20 mA output is isolated from line power and earth ground. Do not run 4-20 mA cables in the same conduit as power. Operation of this output is covered in section 5.2 *Setting the 4-20 mA*. Optional optically isolated outputs are available as a factory installed option.

Note: The installation of the 4-20 mA isolator will render the RS-485 non-operational.

Ensure each instrument is not powered when connecting the 4-20 mA. To prevent damage to the instrument, ensure that power is disconnected prior to making connections. For ease of connecting, remove the plug in terminal block. Polarities of the connections are labeled beneath this termination.

4.0 OPERATION

The HS3420 allows for the measurement of the oil concentration of process water on-line. The oil concentration of the process water is reported in ppm, but may be reported in mg/L. Readings above 100 ppm are outside the range of this instrument. Readings above 100 ppm will cause the display to flash indicating an over range condition.

During normal operation, the instrument will have the arrow beside **AUTO** highlighted with the current scale displayed on the lower row of the display and the measured reading on the upper row of the display (see illustration below).



4.1 Routine Measurement

The following steps describe how to measure the oil concentration of a sample using this instrument:

Apply power to the instrument and allow the unit to warm up (typically 45 minutes – 1 hour on initial commissioning).

When a continuous process stream is flowing through the instrument, the instrument will display the measured oil concentration of the sample by displaying it on the LCD screen. In addition, the equivalent signal is provided on the analog (4-20 mA) output, or the digital output, depending on the options selected.

4.2 Security Access Feature

The instrument is equipped with a security access code feature that can be activated in the configuration mode. If the security feature is enabled (factory set for OFF), the screen shown in the illustration below will appear when the **MODE/EXIT** button is pressed.

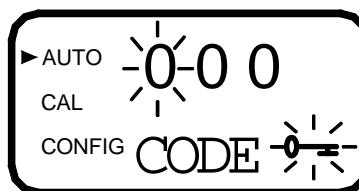

The security code (333) must be entered to gain access to **CAL** or **CONFIG** menus. Notice that the first number in the code is flashing; the flashing indicates that this is the number to be changed. Use the \blacktriangle or \blacktriangledown arrows to select the first of the three numbers in the code and then press the \blacktriangledown button to accept the first number of the code. Now enter the second number in the code. Proceed as with the first number followed by \blacktriangledown . Then repeat the process for the third number in the access code, and finish with the \blacktriangledown button.

If the valid access code has been selected, the instrument will be directed to the calibration mode. If the wrong access code is selected, the instrument will return to the **AUTO** mode. Refer to section 5.7 *Enabling the Security Access* for more information.

5.0 INSTRUMENT CONFIGURATION

The instrument has been designed to provide the ability to customize the instrument according to needs at any time during normal operation. This mode has been split into sub-menus to facilitate instrument configuration. This section describes how to use each of the sub-menus to configure the instrument. While in the configuration mode, the instrument has a time-out feature that automatically returns the system operation to the **AUTO** mode after a fifteen (15) minute period.

Enter the **CONFIG** mode of the instrument by pressing the **MODE/EXIT** button until the arrow beside **CONFIG** is illuminated.

Note: To exit the CONFIG mode, press the MODE/EXIT button.

5.1 Selecting the Output (O/P)

The first configuration selection is the **O/P**. The selections are **4-20** for the 4-20 mA output, **485** for the RS-485 and **OFF** if no outputs are required. Select the desired output by using the \blacktriangle and \blacktriangledown buttons. Once the desired output has been set, press the \blacktriangledown button to accept it. The next prompts will depend on the output selected.

5.2 Setting the 4-20 mA



If the 4-20 mA output was turned on, prompts to set the lower (**LOLM**) and upper (**UPLM**) ppm limits corresponding to the 4 mA and 20 mA output levels will be displayed. The first prompt will be the ppm limit assigned to the 4 mA output level:

Select the ppm to assign to the **LOLM** using the \blacktriangle and \blacktriangledown buttons.

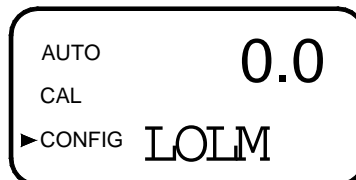

Once the desired ppm level has been set, press the \blacktriangledown button to accept it.

The next, prompt will be the ppm level assigned to the 20 mA output level (**UPLM** on the lower row of the LCD display). Select the ppm level to assign to the **UPLM** using the \blacktriangle and \blacktriangledown buttons. Once the desired level has been set, press the \blacktriangledown button to accept it.



5.3 Configuring the RS-485 Port

If the instrument is equipped with this option, and the I/O selection is changed to **485**, prompts will appear for setting the baud rate and the address.

Select the correct baud rate (1200, 2400, 4800, 9600, or 19200) for operation of the I/O port by pressing the \blacktriangle or \blacktriangledown buttons to change the displayed baud rate.

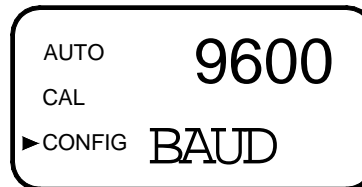

Press the \blacktriangledown button to continue on and select the desired instrument address using the \blacktriangle or \blacktriangledown buttons. Once the selection is satisfactory, press the \blacktriangledown button.



To enable the Modbus mode, select **ASCII** or **RTU**. Refer to the Modbus Manual, if this option was purchased, for more information.

5.4 Configuring the Alarms

Two relays are provided that are designed to operate as two independent programmable alarms. Three types of information must be input to fully program each alarm:

1. The alarm function (HI, LO, or OFF)
2. The alarm set point (level at which the alarm activates)
3. The delay time for the alarm: the time (set in seconds) that the set point must be exceeded prior to alarm activation and the time before resetting the alarm (prevents chattering in the relay)

These three items are described below:

Alarm Function: The alarms can either be turned OFF or programmed to operate in one of two different manners:

1. HI alarm: the relay changes state when the measured ppm level is higher than the programmed alarm level for a prescribed amount of time.
2. LO alarm: the relay changes state when the measured ppm level is lower than the programmed alarm level for a prescribed amount of time.

Note: The relays automatically change state when an internal system failure is detected.

Alarm Set Point: The level at which an alarm activates is called the alarm set point. On the instrument, the alarm set point is designated as "S/P". The set point is adjustable to any valid ppm level over the range of the instrument in steps of 0.01 ppm.

Alarm Delay Time: The alarm delay times are used to prevent chattering of the alarm when the measured ppm level is close to the set point. The function of the delay times is as follows:

Delay On: The ppm level must exceed the alarm set point continuously for at least this number of seconds before the alarm activates.

If the delay on time is set at 5 seconds and the process ppm level exceeds the set point continuously for only 4 seconds, the alarm will not be activated. However, process ppm level exceeds the set point continuously for 5 seconds or more, the instrument will activate the alarm.

Delay Off: The ppm level must not exceed the alarm set point continuously for at least this number of seconds prior to deactivation of the alarm.

If the delay off time is set to 5 seconds and the process has exited out of the alarm condition, the alarm will be reset only if the process is out of the alarm condition for a continuous 5 seconds. Otherwise, the instrument will still signal an alarm condition.

5.4.1 Alarm 1

Alarm 1 Function: The **ALM1** is displayed and the display indicates the current function of alarm 1 (**HI**, **LO**, or **OFF**). Use the **▲** or **▼** buttons to cycle through and select the desired function. Press the **↵** button to accept the selection.

If the alarm was turned **OFF** a prompt will appear to set up alarm 2 (go to section 5.4.2). If, on the other hand, one of the other functionalities was selected a prompt will appear to set the delay times.

Alarm 1 Set Point: This prompt is used to select the set point for this alarm; this is indicated by "S/P" shown on the lower row of the display. Select the desired alarm level by using the **▲** and **▼** buttons. Once the desired set point has been set, press the **↵** button to accept it.

Alarm 1 Delay Times: **Delay On:** The following display will appear to allow to select the number of seconds currently set for the "delay on" time.



The current selected number of seconds will be shown. Select the desired number of seconds for the "delay on" time for this alarm using the **▲** and **▼** buttons. Once the desired delay time has been set, press the **↵** button to accept it.

Delay Off: Next, the following display will appear to select the number of seconds currently set for the "delay off" time.



The current selected number of seconds will be shown. Select the desired delay off time for this alarm using the **▲** and **▼** buttons. Once the desired delay time has been set, press the **↵** button to accept it. After the settings for alarm 1 have been completed, prompts will allow for the set up of the information on alarm #2.

5.4.2 Alarm 2

Repeat the procedure listed in section 5.4.1 to set up the parameters for alarm 2. If a selection was made to turn the alarm **OFF**, the next selection for the speed of response **RESP** is shown. If one of the other functionalities is selected, a prompt to set the delay times and the set point, as with Alarm #1, will be displayed.

5.5 Offset Setting

OFST (Offset) is used only for factory setting.

5.6 Setting the CAL1 and CAL2

The ppm values for the two calibration points (CAL1 and CAL2) must be determined before calibration. See section 6.2 to determine your ppm values. These are entered as the following:

Push the \downarrow button until **CAL1** is displayed on the lower row. On the top row of the display will indicate the ppm value of sample or standard. Change this value by using \uparrow or \downarrow buttons. Once the desired ppm value has been set, press the \downarrow button to accept it.

The next, **CAL2** is displayed on the lower row. On the top row of the display will indicate the ppm value of sample or standard. Change this value by using \uparrow or \downarrow buttons. Once the desired ppm value (normally, 0ppm) has been set, press the \downarrow button to accept it.

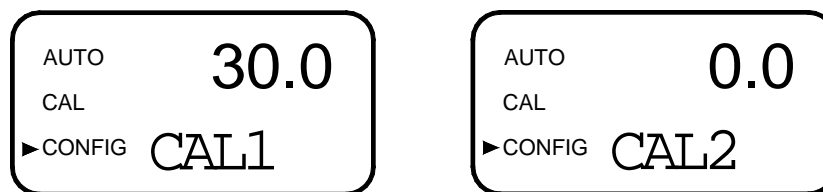

5.7 Enabling the Security Access Code

The instrument is equipped with a security access. If this option is turned on, the user is required to input the access code into the instrument to get to any mode other than **AUTO**. The only code is **333**. This code may not be changed. See section 4.2 for more information on this security feature. The security key icon will be visible and flashing on the display whenever the access option is selected using the \uparrow or \downarrow buttons. (**On** or **OFF**).



5.8 Extended Settings

The last few settings are grouped together to prevent them from being adjusted by accident.

If extended settings is set to **OFF**, pressing the \downarrow button will save all settings and the HS3420 will automatically return to the normal **AUTO** mode of the instrument.

To gain access to the extended settings, select **On** using the \uparrow or \downarrow buttons and press the \downarrow button.



5.9 Speed of Response

The speed of response for both displayed and output values of ppm can be adjusted in this menu. The default setting is 10, however 100 response speeds are available. Although the displayed number is a relative speed, the approximate response time, in seconds, is the displayed number multiplied by 5. Select the desired speed of response using the ▲ and ▼ buttons. Press the ↵ button to accept it.

To avoid reading air and other anomalies, select the slowest speed (highest number). Select the fastest response where monitoring of rapid changes is needed.



5.10 Displayed Resolution

The instrument is equipped with the ability to display several levels of resolution. The instrument can display up to four digits to the right of the decimal place for oil concentration readings below 10 ppm. The default setting is 0.1 ppm. If the last digit or two is not stable, adjust the resolution to hide these digits.



Change the resolution by pressing the ▲ or ▼ button. When the desired digit resolution has been selected, press the ↵ button.

5.11 LCD Backlight Brightness

The LCD backlight brightness may need to be adjusted. This is of particular interest if multiple instruments are located in the same area and it is desired for the entire group to have the same appearance. Ten levels are available. The default brightness is 8.



Change the brightness by pressing the ▲ or ▼ button. When the desired brightness has been selected, press the ↵ button.

5.12 Setting the Units

The most common unit is ppm, however the instrument can display in mg/L.. All instruments are shipped from the factory set in ppm mode. Make a selection using the \blacktriangle and \blacktriangledown buttons then press the \blacktriangledown button.

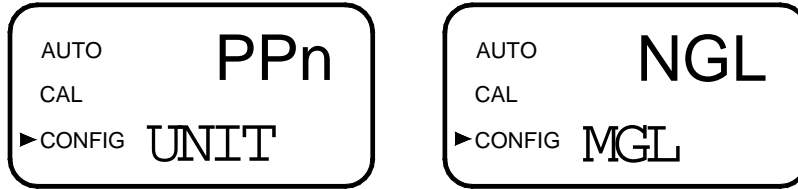

5.13 Ultrasonic Cleaning

This allows for a selection menu to turn off the ultrasonic cleaning function if desired. The default mode is On. Make a selection using the \blacktriangle and \blacktriangledown buttons then press the \blacktriangledown button.



5.14 RS-485 Parameters

For instruments manufactured on or after June 2003, the following menus can be used to modify the RS-485 parameters. These menus will only appear if the RS-485 is enabled (see 5.1). The default is 8 Bit, no (nOnE) Parity, 1 Stop Bit. Make selections using the \blacktriangle and \blacktriangledown buttons then press the \blacktriangledown button to move to the next menu.



5.15 Desiccant Alarm

When the humidity detector in the HS3420 indicates that the internal environment is close to the point where humidity could cause condensation, the instrument will display **DESC** as a warning. If desired, a desiccant warning can activate the alarms and send the 4-20mA to 2mA. To activate the alarms when the desiccant fails, select **On** in the **DESC** menu. The default for this menu is **OFF**. Make selections using the \blacktriangle and \blacktriangledown buttons then press the \blacktriangledown button to move to return to **AUTO** mode.



5.16 Saving Configuration Settings

If extended settings is set to **OFF**, pressing the \blacktriangledown button will save all settings and the HS3420 will automatically return to the normal **AUTO** mode of the instrument.

If extended settings is set to **On**, after the last menu of the extended settings, pressing the \downarrow button will save all settings and the HS3420 will automatically return to the normal **AUTO** mode of the instrument.

The **CONFIG** menu may be used at any time to reset or change any of the parameters. The **CONFIG** menu may be exited at any point in the menu by using the **MODE/EXIT** key. Any features that have been modified will be saved.

5.17 Configuration Settings Sheet

PARAMETER	DESCRIPTION	FACTORY SETTING	USER SETTING
O/P	Output selection	4-20mA	
LOLM	The lower ppm limit corresponding to 4 mA	0.0ppm	
UPLM	The higher ppm limit corresponding to 20 mA	100.0ppm	
ALM1	The current function of alarm 1	HI	
S/P	The set point of Alarm 1	30 PPM	
DLY[^]	The number of seconds for the "delay on" time for the alarm 1	5 seconds	
DLY^v	The number of seconds for the "delay off" time for the alarm 1	5 seconds	
ALM2	The current function of alarm 2	HI	
S/P	The set point of Alarm 2	50 PPM	
DLY[^]	The number of seconds for the "delay on" time for the alarm 2	5 seconds	
DLY^v	The number of seconds for the "delay off" time for the alarm 2	5 seconds	
OFST	The operational status of the offset function	OFF	
CAL1	The ppm value of the first calibration point	30 PPM	
CAL2	The ppm value of the second calibration point	0 ppm	
CODE	The access code into the instrument	OFF	
EXTD	The last few settings (see the following) are grouped together	OFF	
RESP	The speed of response for both displayed and output values	10	
RES	The decimal place for the ppm readings	0.1	
BRT	The LCD backlight brightness	8	
UNIT	The instrument display unit	ppm	
CLN	The ultrasonic cleaning function	ON	
DESC	The Desiccant alarm function	OFF	

6.0 INSTRUMENT CALIBRATION

The instrument was calibrated and tested prior to leaving the factory using 30ppm turbine oil. Therefore, it is possible to use the instrument directly out of the box. Under normal conditions, re-calibration is recommended at least once every three months.

Relay contacts are held at the last valid condition and will not change state while the instrument is in the calibration and/or in the configuration mode. While in the calibration mode, the instrument has a time-out feature that automatically returns the system operation to the **AUTO** mode after a fifteen (15) minute period of inactivity.

6.1 Calibration Methods

There are 3 methods available to calibrate the HS3420. Each method requires two calibration inputs: a zero calibration using 0ppm clean water and a span calibration using a known ppm concentration.

The HS3420 is for an alarm and trending monitor only. Therefore, absolute calibration accuracy is not required. Method 3 is widely used and an acceptable method for calibration.

Method 1: Make a sample of a known concentration using the oil type and mixing it with water. Blending samples that are representative of sample conditions is difficult to do. Using Acetone in equal parts to the oil will aide in blending the sample.

Method 2: Have an oil contaminated process sample analyzed by a local lab to determine the ppm value. Use a quantity of the same sample for calibration.

An NTU sample can be tested after calibration to assign a PPM value for future calibration using Method 3.

Method 3: Use a NTU Formazin sample that closely relates to the oil response factor.

Typical Response Factors

Oil Type	10NTU	Note
Diesel / Turbine Oil	30 ppm	
customer oil name	ppm	Customer oil name and ppm value of 10 NTU from Method 2

NTU Formazin samples are available from Arjay Engineering Ltd or laboratory supply outlets. Arjay calibration Standards are stable and have a 12 month shelf life.

6.2 Calibration Procedures

Before the calibration, the ppm values of the samples or standards should be known.

1. See section 5.6 and 5.16 if the ppm values of CAL1 (first point of calibration) and CAL2 (second point of calibration) need to be changed. These are factory set at 30 ppm and 0 ppm.
2. Select the calibration function of the instrument by pressing the **MODE/EXIT** button once. The arrow beside **CAL** will be illuminated on the display. The lower display shows the ppm value set during configuration (CAL1), see section 5.6.

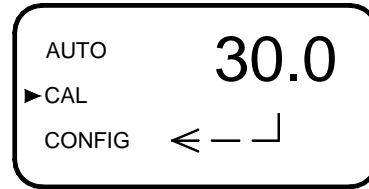
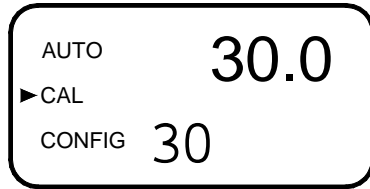

3. Remove the flow through unit.
4. Insert the requested standard or known ppm sample that represents the ppm value on the lower display.
5. Press the \downarrow button to accept the first point calibration.
6. The upper display will count down 30 seconds and then display the ppm value.
7. The lower display will now change to the second point calibration.
8. Insert the requested 0ppm clean water of standard.

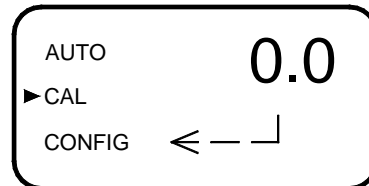
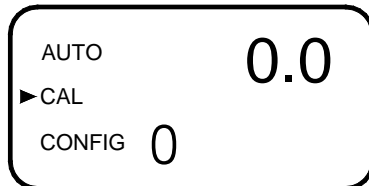

9. Press the \downarrow button to accept the second point calibration.
10. The upper display will count down 30 seconds.
11. The instrument will return to **AUTO** mode at the end the calibration.
12. Calibration is now completed.
13. Reinsert the flow through unit.

Note: During calibration, the fan inside the instrument is turned off to extend the life of the desiccant. The fan will be turned on during calibration countdowns and after returning to the AUTO mode or after five minutes, which ever comes first. It is recommended that the measurement chamber be kept covered during the calibration period and that the flow through cuvette be replaced immediately after the calibration to prevent premature saturation of the desiccant.

6.3 Calibration Error

If the screen shown below, is displayed after calibration, the internal diagnostics have determined that the calibration standards were either bad or that they were inserted in the wrong order. Either check the standards and recalibrate



To recalibrate press the MODE key and start the calibration sequence again.

7.0 ADDITIONAL FEATURES AND OPTIONS

7.1 Backlit LCD

The backlit LCD allows for easier readability of the LCD display in low light or no light conditions. The backlight is intended for continuous operation. The brightness is adjustable from a menu in the **CONFIG** mode.

7.2 Ultrasonic Cleaning

This option is used to continuously clean the flow through cuvette. It is not intended to clean cuvettes that are already dirty, or replace manual cleaning entirely. The system will increase the time between cleanings dramatically. Please note that the system requires the use of a special cuvette. This cuvette must be used for the system to operate correctly.

The system works by sending an ultrasonic frequency through spring connections into a piezo transducer bonded to the bottom of a flow through cuvette.

The system can detect that an incorrect cuvette is installed, an error has occurred in the transducer or the transducer is not making contact with the spring connections. This error is indicated by **CLN** being posted to the lower screen. Since this is an error condition, the alarms will be set and the 4-20 mA will be sent to 2 mA.

If the correct cuvette is installed, and the error is still posted, try rotating the flow through unit slightly to improve the connection. If this fails to work, the cuvette may have to be replaced. The detection for this cuvette only operates in **AUTO** mode. If the system is operating correctly **AUTO** will flash.

Note: The cuvette must be completely dry before it is inserted into the sensor. If there is any visible moisture present on the cuvette or transducer, there is a great risk of damaging the sensor electronics and the transducer. Be sure to clean and dry the cuvette completely just before inserting it into the sensor.

After installing a cuvette, there will be a 30 minute period where the lower screen will post **DRY** to the lower screen. During this time, the ultrasonic circuit will not operate to allow the Vapor Purge system to remove all moisture from the ultrasonic transducer. The Vapor Purge system can NOT remove large droplets of water, only residual moisture. The DRY message is normal and is not considered an alarm condition; therefore no alarms will be implemented. If the cuvette is removed during this period no **CLN** alarm is posted until the 30 minute **DRY** period times out.

Note: for the Vapor Purge system to function properly, all instrument seals must be maintained and the desiccant pack must be in good condition (no DESC display).

7.3 RS-485 Outputs

Modbus protocol communication is optionally available on all models. The Modbus information is covered in a separate manual included with this option.

8.0 TROUBLESHOOTING MAINTENANCE

8.1 HS3420 Fault Detection

The HS3420 performs continuous diagnostic monitoring. In the HS3420 there are three levels of fault detection; warnings, errors and failures. Any faults are displayed in a queue form in the bottom row of the LCD.

A warning is simply a screen indication of a problem. No alarms are activated. If the desiccant alarm is turned off and the desiccant becomes saturated, a screen warning of DESC will appear.

An error indicates a failure or a problem that usually can be corrected by the operator. These errors consist of lamp out (LAMP), 4-20 mA loop open (MA), bad calibration (CAL), if desiccant alarm activated and replacement required (DESC), if enabled no flow (FLOW) (if equipped with the flow switch). If the HS3420 is equipped with ultrasonic cleaning, an additional message will indicate that the ultrasonic transducer is not making contact or the flow through has been removed (CLN). If any of these conditions occurs, both alarm relays will be activated and the 4-20 mA output will be held at 2 mA. If any of these errors occur the instrument will still display readings, however the accuracy is not known and the instruments readings should not be trusted.

A failure is a system fault. This is NOT a problem that the operator can correct, and the unit must be returned to the factory for service. These failures consist of failures in the CPU, A/D, EEPROM or other devices internal to the instrument (FAIL). If a failure occurs, the instrument will not function properly and will display the word FAIL on the lower row, both alarm relays will be activated and the 4-20 mA output will be held at 2 mA (if 4-20 mA is selected).

If any fault conditions occur, the message indicating the fault will be shown on the lower row of the display.

8.2 System FAIL Message

Normally, this condition indicates that the instrument will require servicing. Contact Technical Service of Arjay Engineering Ltd.

Arjay Engineering Ltd.
2851 Brighton Road
Oakville, Ontario, Canada, L6H 6C9
Phone: (905) 829-2418
Fax: (905) 829-4701
North America 1-800-387-9487
Email: arjay@arjayeng.com
www.arjayeng.com

8.3 Diagnostic Chart

Symptom	Cause	Cure
Lower display shows MA	4-20 mA loop open	Check wiring. See sections 3.3.4 and 7.2
Lower display shows DESC	Desiccant pouch bad	Change desiccant pouch. See section 9.2
Lower display shows LAMP	Lamp failed	Replace lamp. Refer to section 9.3
Lower display shows FLOW	Sample flow has stopped	Restore flow. Contact Arjay about factory installed option
Lower display shows FAIL	Major system fault	Refer to section 9.1 & 9.2
Readings are higher than expected	(1) Bubbles in solution	(1) Ensure that the drain vent is open and is not obstructed. See section 3.2.2. (2) Apply backpressure. See section 3.2 and figure 4 (3) For sever cases of bubbles a stilling chamber is available. Call Arjay Engineering Ltd.
	(2) Condensate or leaky cuvette	Check flow through cuvette for condensate or leaks.
	(3) Flow through cuvette dirty	Clean cuvette. See section 9.1
	Instrument out of calibration	Recalibrate. Refer to section 5
Readings are erratic	(1) Bubbles in solution	(1) See above
	(2) Debris in flow through	(2) Clean debris from cuvette
Readings are lower than expected	Instrument out of calibration	Recalibrate. Refer to section 5
Upper display flashes	Sample Over-Range	Check sample. Sample may be too high to read.

8.4 Technical and Customer Assistance

If for any reason assistance is needed regarding this instrument please do not hesitate to contact Technical Service of Arjay Engineering Ltd:

Arjay Engineering Ltd.
2851 Brighton Road
Oakville, Ontario, Canada, L6H 6C9
Phone: (905) 829-2418
Fax: (905) 829-4701
North America 1-800-387-4701
Email: arjay@arjayeng.com
www.arjayeng.com

9.0 ROUTINE MAINTENANCE

9.1 Cleaning the Flow Through Cuvette

Measurement cuvettes used for both grab sample and the flow through should be clean and free of marks or scratches. Cleaning is accomplished by cleaning the interior and exterior with a detergent solution and then rinsing several times with distilled or de-ionized water. The cuvette can be replaced by first shutting off the flow using the provided shutoff clamp; unscrewing the old cuvette and replacing with a fresh clean one.

9.2 Replacing or Installing the Desiccant Pouch

The HS3420 continuously checks the condition of the desiccant. When the desiccant gets in such a condition that it may cause problems, the instrument will display **DESC** on the lower portion of the display to indicate the presence of humidity. See 5.15 *Desiccant Alarm*.

Proper use of the supplied desiccant is essential in maintaining the performance of the instrument. The desiccant has been designed to have a long life; however, replacement of the desiccant pouch will be required from time to time.

It is essential that the enclosure seal on the instrument base be maintained to ensure adequate desiccant life. Inspect the seal each time the desiccant pouch is replaced. Replace or reseal the seal if it is found to be defective.

The desiccant should be replaced when the instrument displays **DESC**. A new sealed desiccant pouch and indicator card are available from Arjay Engineering Ltd. To initially install or remove the old desiccant, simply unscrew the four corner thumbscrews and remove the electronics half of the instrument. Open the bag protecting the new desiccant pouch and replace (or install for a new instrument) in the desiccant tray assembly. To speed up the recognition, by the instrument, of the new desiccant it will be necessary to reset the instrument by disconnecting the sensor interconnect cable for 2 seconds and then reconnecting it.

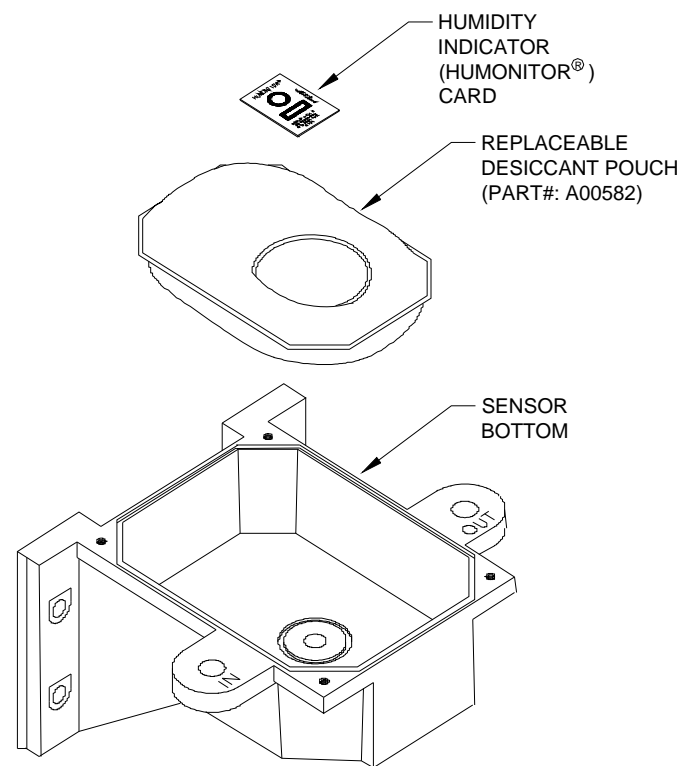

Note: Once the bag is opened, install the desiccant pouch immediately to prevent premature degradation of the desiccant.

9.3 Replacing the Source Lamp

The source lamps in the HS3420's are designed for long life. The white light version is rated for 7 years. If the lamp should need replacement, we recommend calling Arjay Engineering Ltd for assistance.

MOUNTING TEMPLATE

ALL DIMENSIONS ARE IN INCHES (MILLIMETERS)

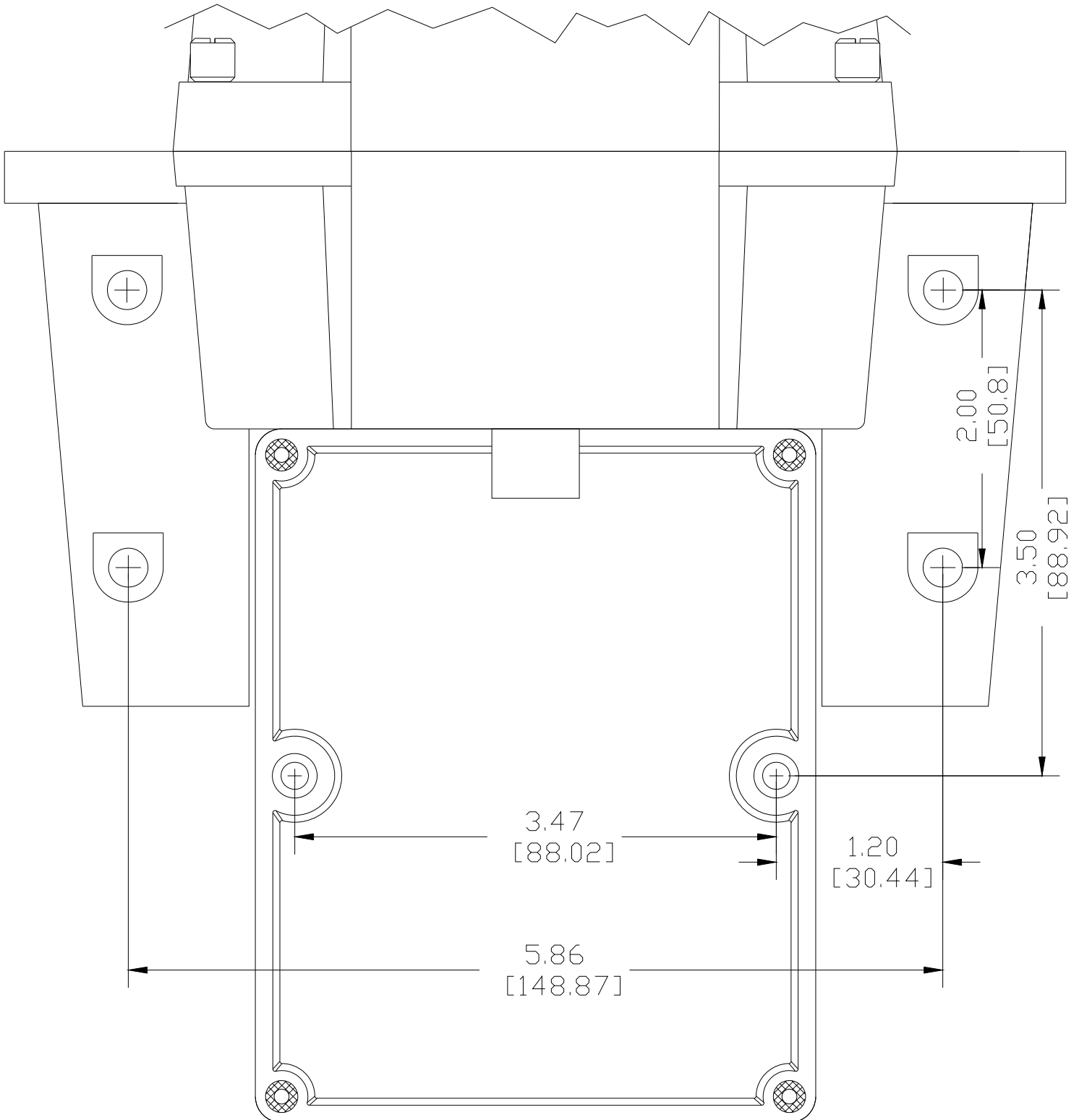

NOTE:

- 1) SEE THE MOUNTING INSTRUCTIONS IN THE MANUAL FOR MOUNTING HARDWARE SIZES.
- 2) PROVIDE AT LEAST 8 INCHES (200 MM) OF FREE SPACE ABOVE THE SENSOR FOR EASY REMOVAL OF THE FLOW HEAD AND INSERTION OF THE CALIBRATION STANDARDS.